

DETAIL A
SCALE 1 : 10

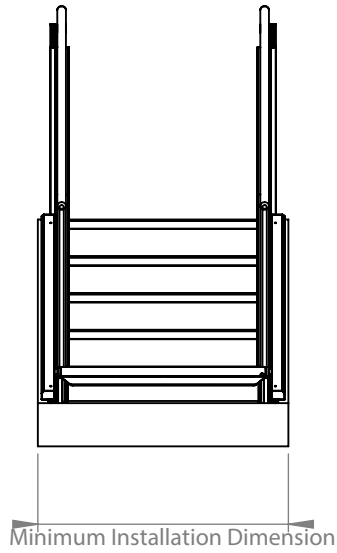

- 1000 mm (model 700 mm)
- 1100 mm (model 800 mm)
- 1200 mm (model 900 mm)
- 1300 mm (model 1000 mm)

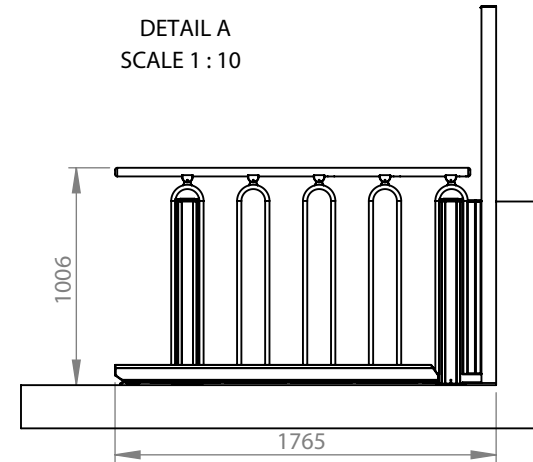
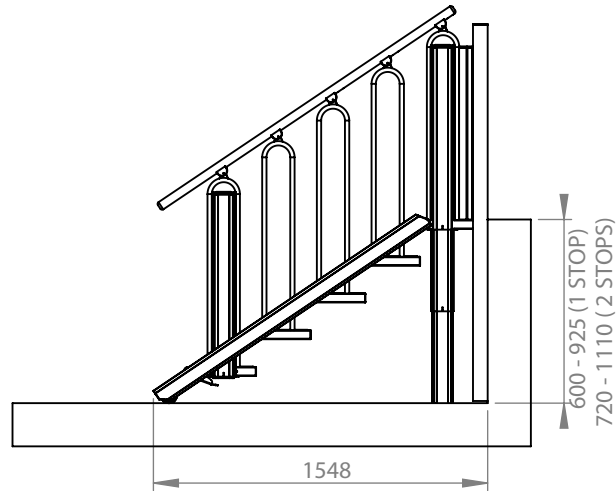

Specs.	Choice	Model:	5 STEPS	
Installation	Indoor	Balustrade:	Round	Last change date: 23-03-2018
Handrails	Oak	Lifting Capacity:	400 kg	Product Name
Step Inserts	Oak	Drawn by:	MP	FLEXSTEP V2
Colour	Akzo Nobel 900	Customer :		Scale: 1:35 A4
Packing	Carton or Wood Pallet Box			
Op. Panel				



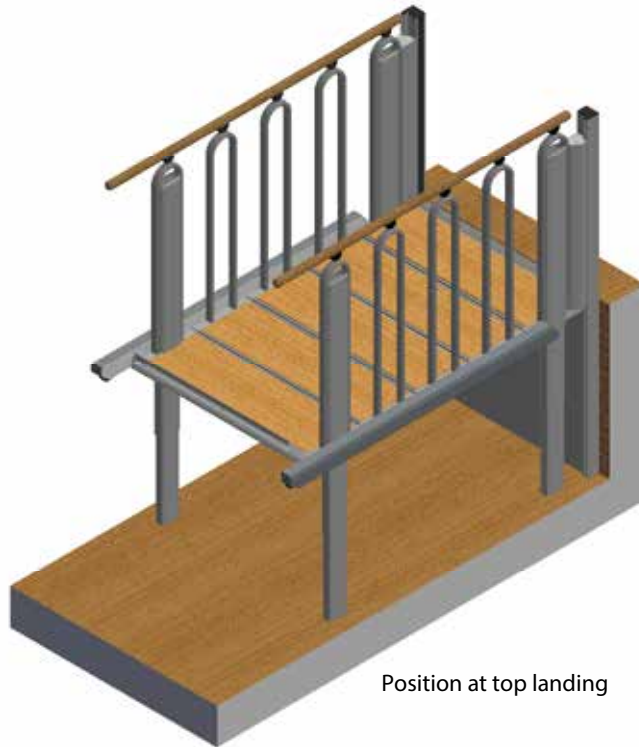

Position at top landing

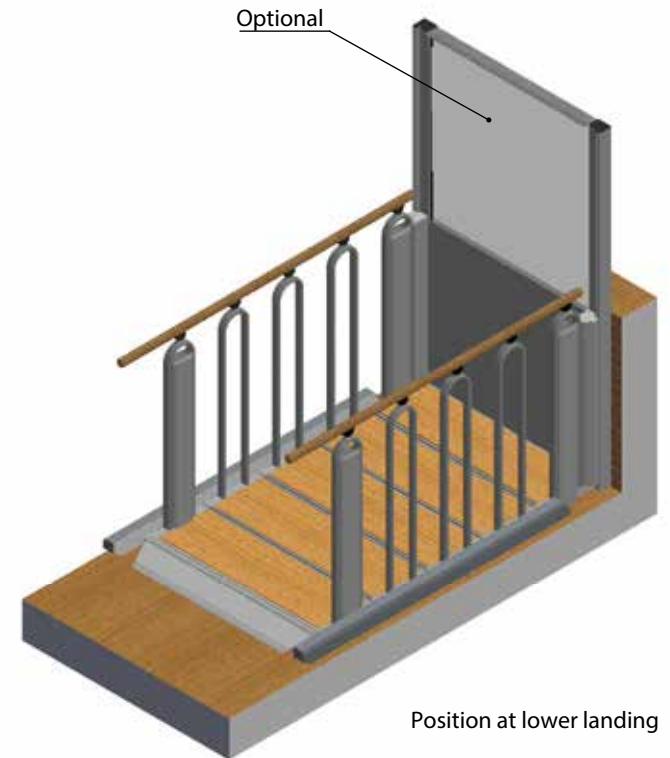

Optional

Position at lower landing



Staircase

Specs.	Choice	Model:	5 STEPS	
Installation	Indoor	Balustrade:	Round	Last change date: 23-03-2018
Handrails	Oak	Lifting Capacity:	400 kg	Customer :
Step Inserts	Oak	Drawn by:	MP	
Colour	Akzo Nobel 900			
Packing	Carton or Wood Pallet Box			
Op. Panel				
				Product Name
				FLEXSTEP V2
				Scale: 1:30 A4



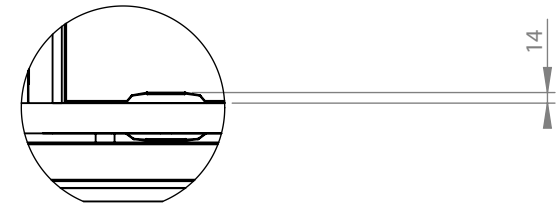
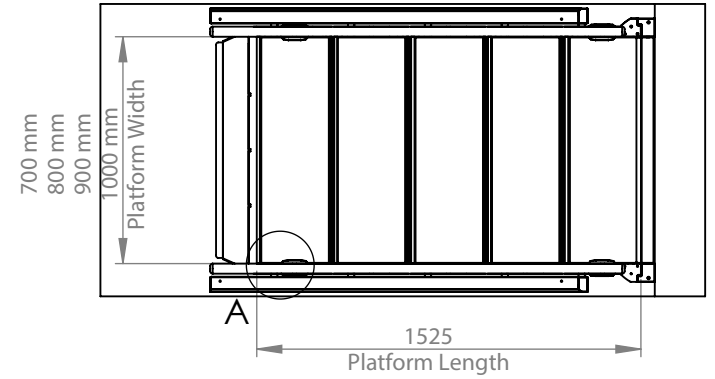
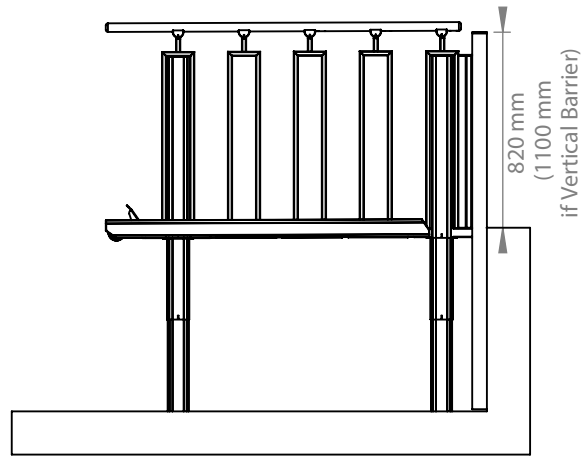
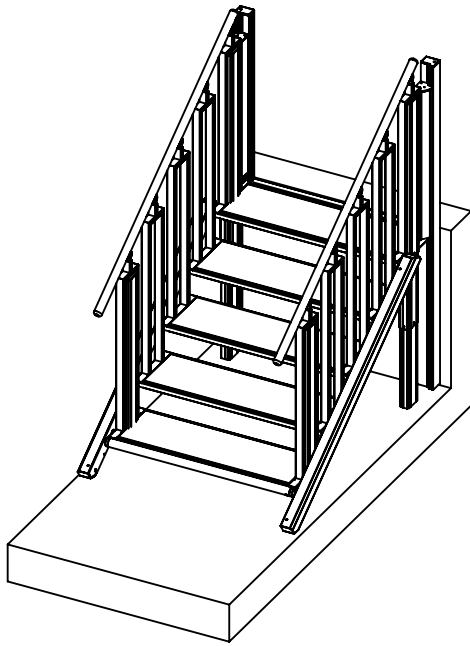

DETAIL A
SCALE 1 : 10

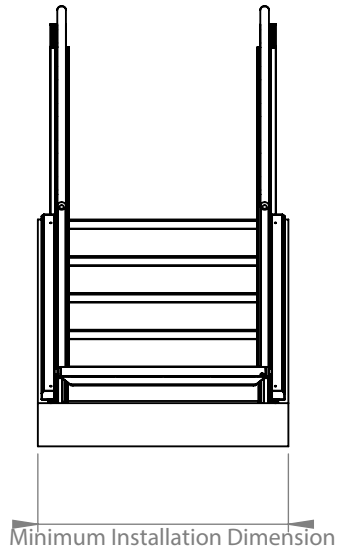
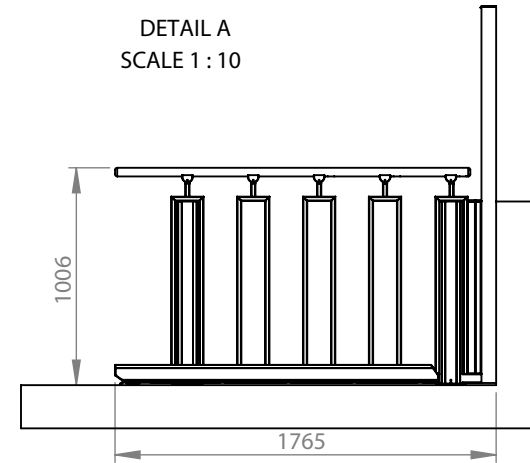

Minimum Installation Dimension
1000 mm (model 700 mm)
1100 mm (model 800 mm)
1200 mm (model 900 mm)
1300 mm (model 1000 mm)

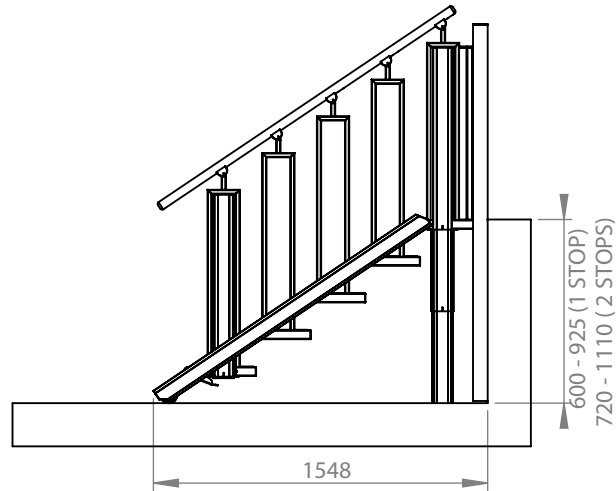

Specs.	Choice	Model:	5 STEPS	
Installation	Indoor	Balustrade:	Square	Last change date: 23-03-2018
Handrails	Oak	Lifting Capacity:	400 kg	Product Name FLEXSTEP V2
Step Inserts	Oak	Drawn by:	MP	Customer :
Colour	Akzo Nobel 900			Scale: 1:35 A4
Packing	Carton or Wood Pallet Box			
Op. Panel				



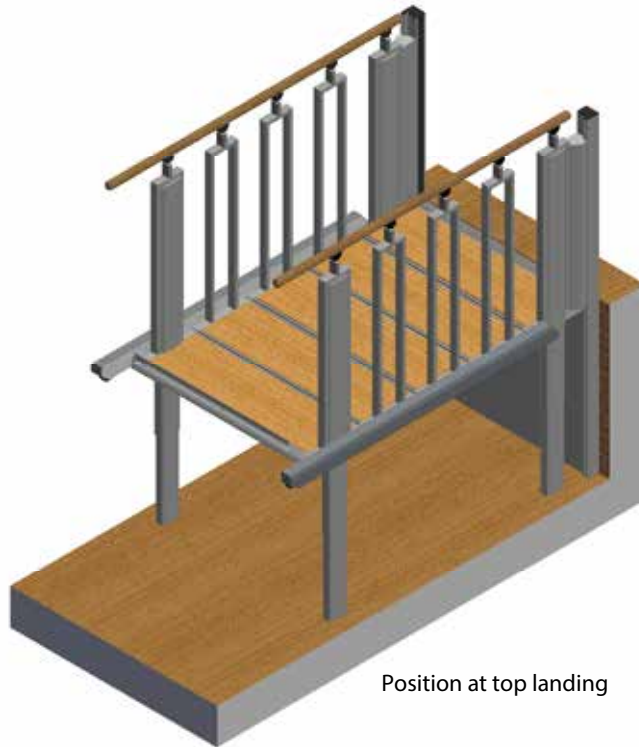

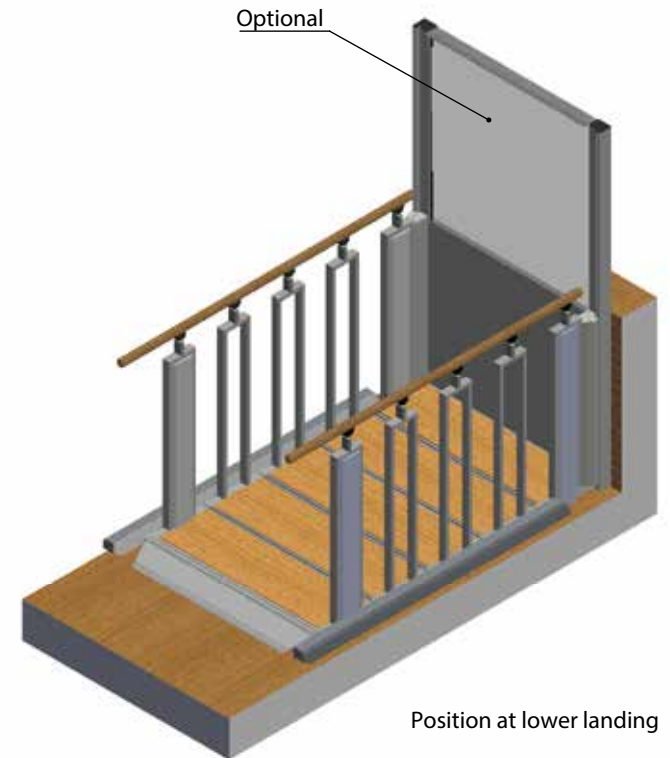

Position at top landing

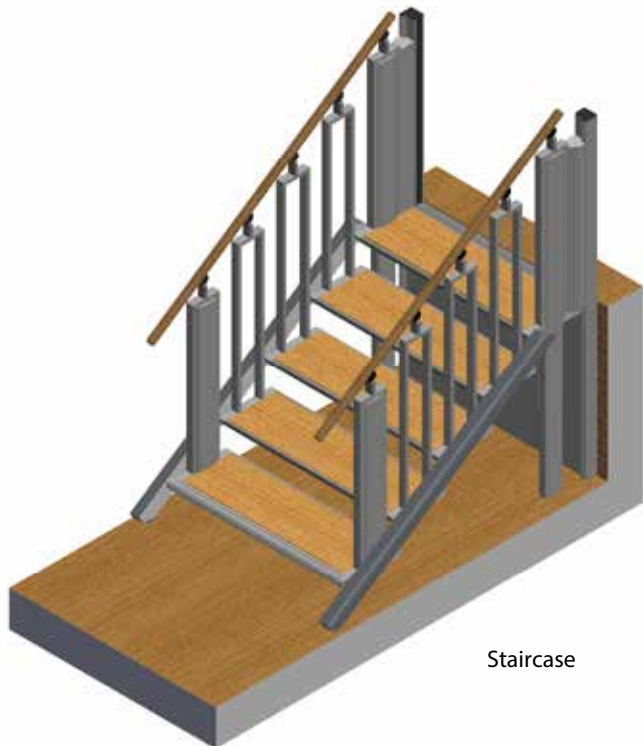

Position at lower landing



Staircase

Specs.	Choice	Model:	5 STEPS		
Installation	Indoor	Balustrade:	Square	Last change date: 23-03-2018	
Handrails	Oak	Lifting Capacity:	400 kg	Customer :	Product Name
Step Inserts	Oak	Drawn by:	MP		FLEXSTEP V2
Colour	Akzo Nobel 900				Scale: 1:30 A4
Packing	Carton or Wood Pallet Box				
Op. Panel					