

DETAIL A  
SCALE 1 : 10

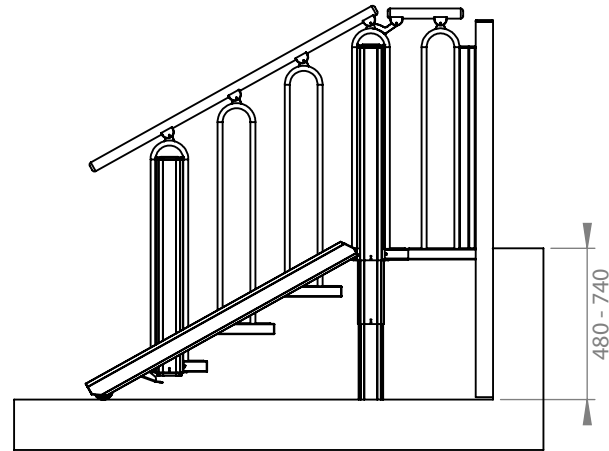
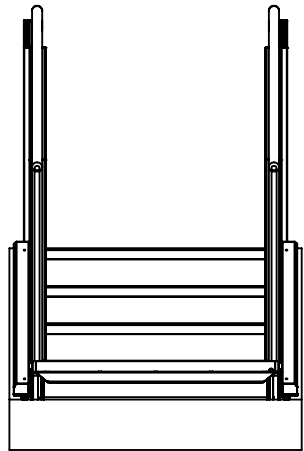
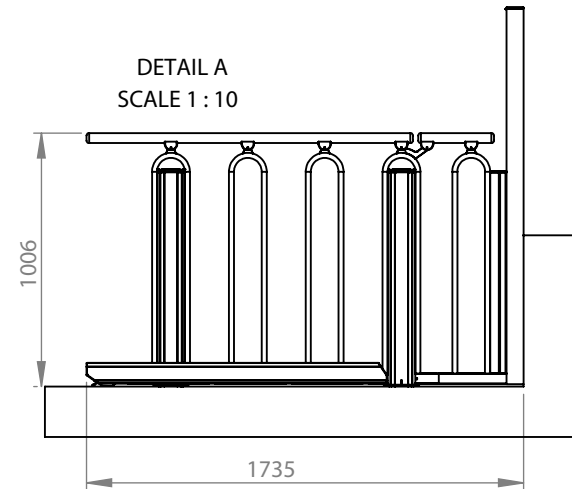

Minimum Installation Dimension

- 1000 mm (model 700 mm)
- 1100 mm (model 800 mm)
- 1200 mm (model 900 mm)
- 1300 mm (model 1000 mm)

Specs.	Choice	Model:	4+1 STEPS	
Installation	Indoor	Balustrade:	Round	Last change date: 23-03-2018
Handrails	Oak	Lifting Capacity:	400 kg	Product Name
Step Inserts	Oak	Drawn by:	MP	FLEXSTEP V2
Colour	Akzo Nobel 900	Customer :		Scale: 1:30 A4
Packing	Carton or Wood Pallet Box			
Op. Panel				



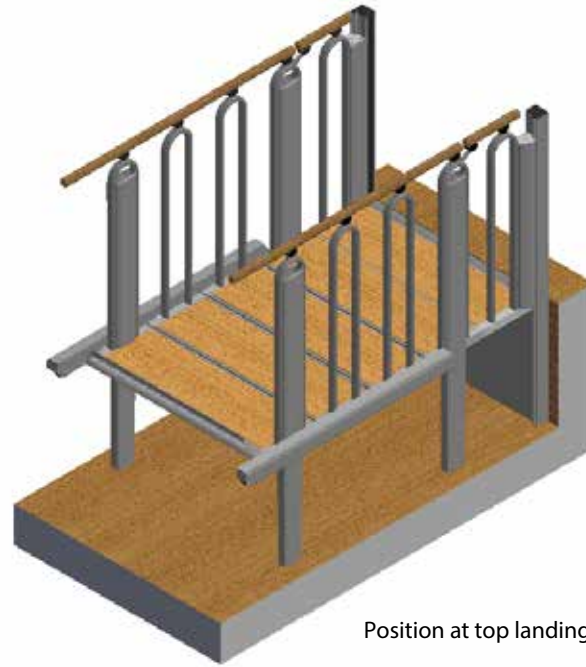

Position at top landing

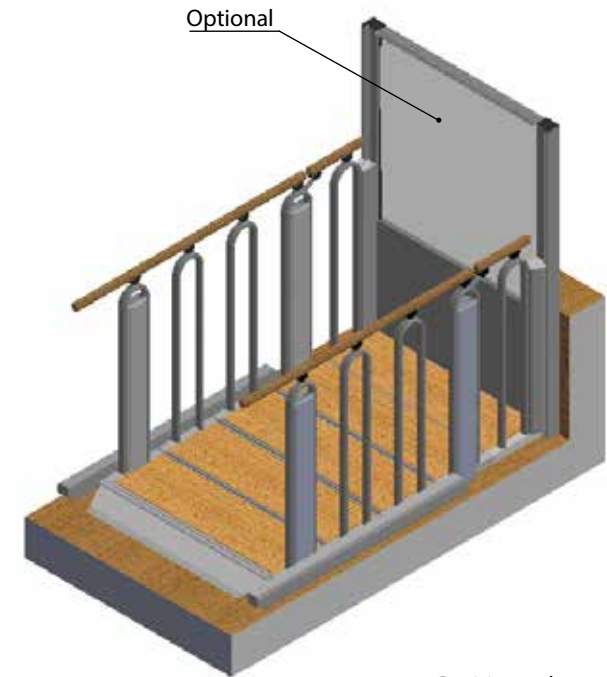

Position at lower landing



Staircase

Specs.	Choice	Model:	4+1 STEPS	
Installation	Indoor	Balustrade:	Round	Last change date:
Handrails	Oak			23-03-2018
Step Inserts	Oak	Lifting Capacity:	400 kg	Product Name
Colour	Akzo Nobel 900			FLEXSTEP V2
Packing	Carton or Wood Pallet Box	Drawn by:	MP	Customer :
Op. Panel				Scale:



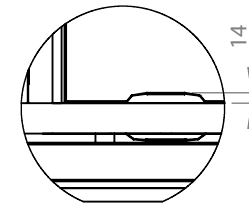
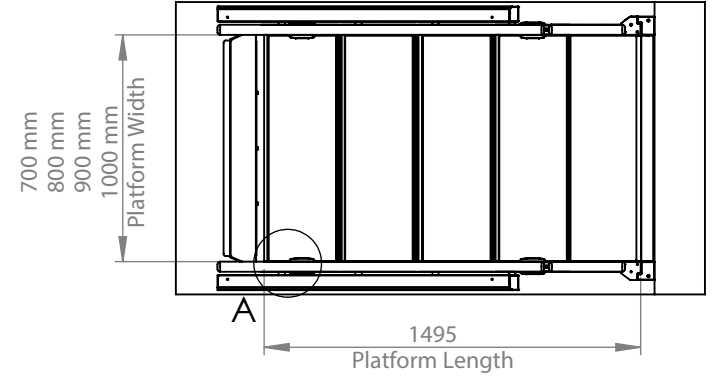
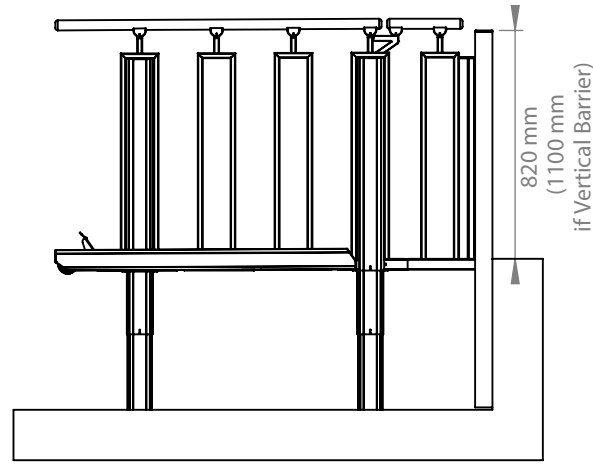
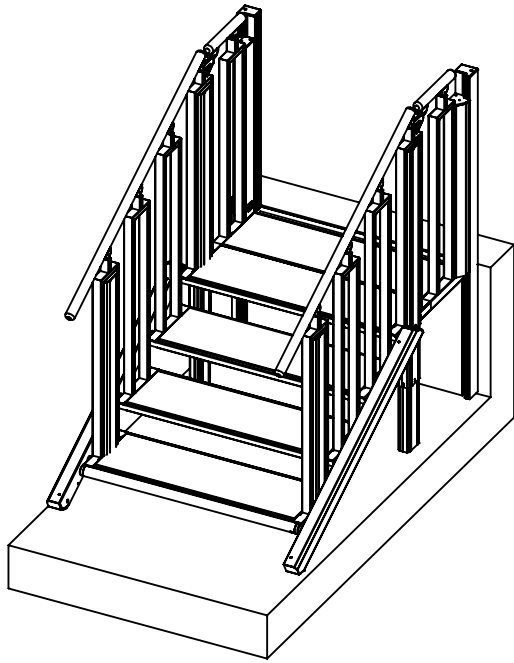

DETAIL A  
SCALE 1:10

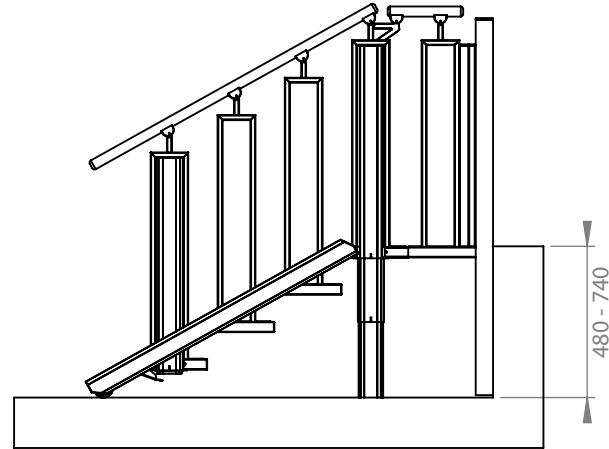
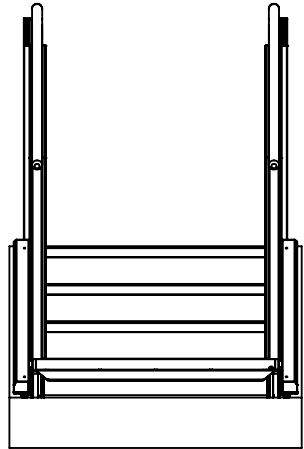
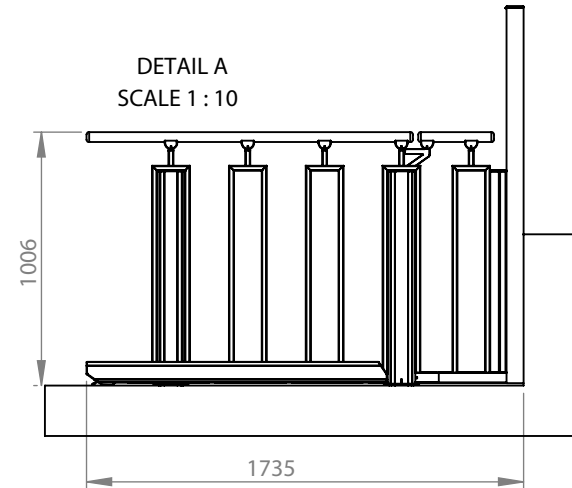

Minimum Installation Dimension  
 1000 mm (model 700 mm)  
 1100 mm (model 800 mm)  
 1200 mm (model 900 mm)  
 1300 mm (model 1000 mm)

Specs.	Choice	Model:	4+1 STEPS	
Installation	Indoor	Balustrade:	Square	Last change date: 23-03-2018
Handrails	Oak	Lifting Capacity:	400 kg	Product Name
Step Inserts	Oak	Drawn by:	MP	FLEXSTEP V2
Colour	Akzo Nobel 900	Customer :		Scale: 1:30 A4
Packing	Carton or Wood Pallet Box			
Op. Panel				



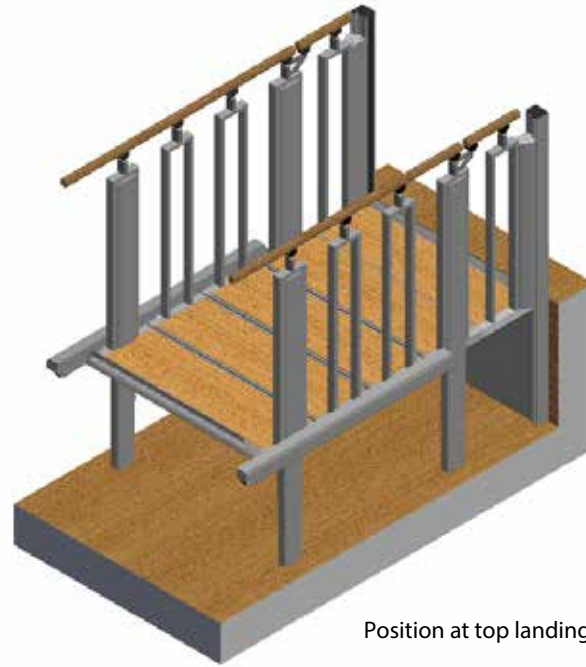

Position at top landing

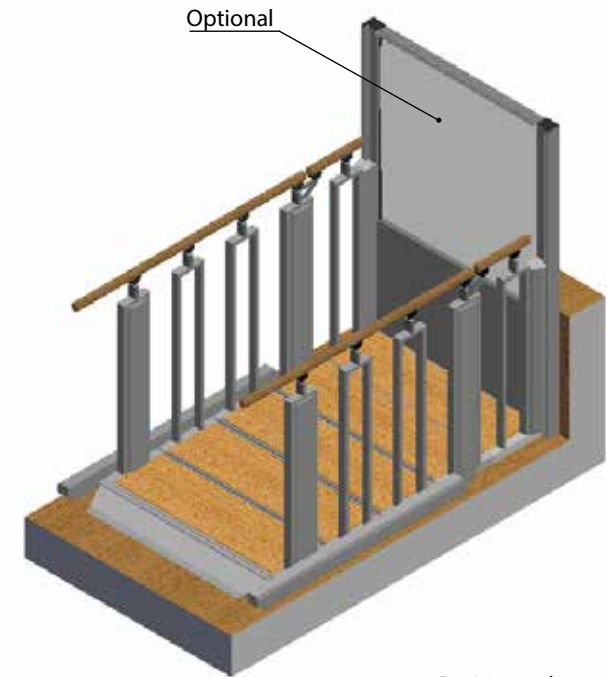

Position at lower landing

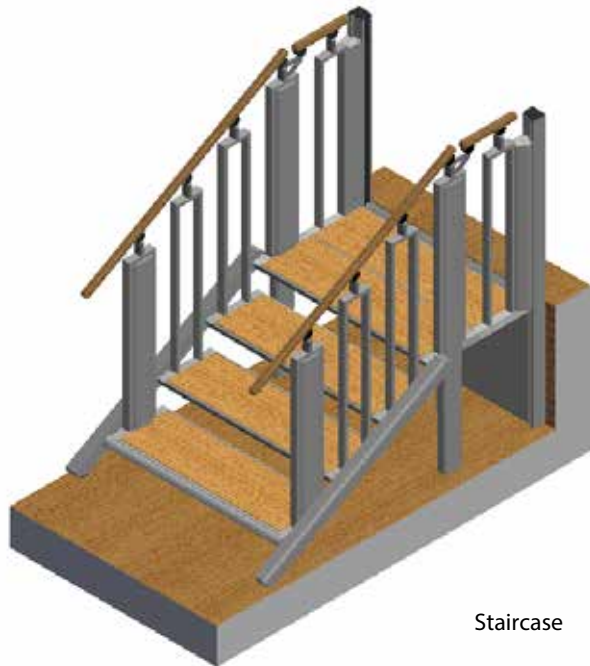

Staircase

Specs.	Choice	Model:	4+1 STEPS	
Installation	Indoor	Balustrade:	Square	Last change date: 23-03-2018
Handrails	Oak	Lifting Capacity:		
Step Inserts	Oak	Colour	Akzo Nobel 900	Product Name
Packing	Carton or Wood Pallet Box	Drawn by:	MP	Customer :
Op. Panel				Scale: 1:30
				A4



Product Name  
FLEXSTEP V2